



Inline flowmeter for continuous measurements

- Economic integration in pipe systems without any additional piping
- 3-wire frequency pulse variant to directly interface with PLC's (PNP and NPN)
- Connection to Bürkert devices in remote variants
- Variant HT for high temperature and pressure (max. 125 °C/max. 40 bar) available

Product variants described in the data sheet may differ from the product presentation and description.

Can be combined with

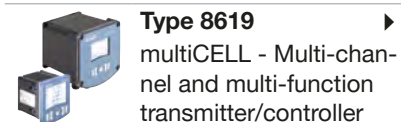

Type 8619 ▶
multiCELL - Multi-channel and multi-function transmitter/controller



Type 8025 ▶
Insertion flowmeter/batch controller with paddle wheel and flow transmitter/remote batch controller



Type 8611 ▶
eCONTROL - Universal controller



Type 8022 ▶
Flow transmitter / Pulse divider



Type 8801 ▶
ELEMENT On/Off Valve Systems with decentralized automation - overview



Type 8802 ▶
ELEMENT continuous control valve systems - overview



PLC

Type description

The paddle wheel flowmeter is especially designed for use with neutral, slightly aggressive, solid free liquids.

The flowmeter Type 8030/8030-HT is made up of a compact sensor-fitting (Type S030/S030-HT) and a transmitter (Type SE30/SE30-HT) quickly and easily connected together by a bayonet catch. The Bürkert designed sensor-fitting system ensures simple installation of the device into all pipelines from DN 06...DN 65.

The flowmeter produces a frequency signal, proportional to the flow velocity, which can be transmitted and processed by a Bürkert transmitter/controller.

Table of contents

1. General technical data	3
1.1. About the device.....	3
1.2. All variants.....	3
1.3. Flowmeter with an Hall or Hall “Low Power” transducer	4
1.4. Flowmeter with coil transducer for high temperature (variant 8030-HT).....	6
2. Product versions	7
3. Approvals	7
3.1. Pressure equipment directive	7
Device used on a pipe	7
4. Materials	7
4.1. Bürkert resistApp	7
4.2. Material specifications	8
5. Dimensions	9
5.1. Transmitter Type SE30	9
5.2. Transmitter SE30 mounted in a sensor-fitting Type S030.....	9
6. Performance specifications	10
6.1. Pressure temperature diagram.....	10
Flowmeter with an Hall or Hall “Low Power” transducer	10
Flowmeter with coil transducer for high temperature (variant 8030-HT).....	10
7. Product installation	11
7.1. Installation notes.....	11
8. Product operation	11
8.1. Measuring principle.....	11
9. Product design and assembly	12
9.1. Product assembly	12
10. Networking and combination with other Bürkert products	12
11. Ordering information	13
11.1. Bürkert eShop.....	13
11.2. Recommendation regarding product selection.....	13
11.3. Bürkert product filter	13
11.4. Ordering chart.....	14
Transmitter Type SE30	14
11.5. Ordering chart accessories.....	14

1. General technical data

1.1. About the device

The flowmeter Type 8030 is available with a wide variety of process connection and

- either with an Hall or Hall “Low Power” transducer



- or with a coil transducer. This variant called High Temperature (8030-HT) is intended for flow measurement at high temperatures.



1.2. All variants

The following data applies to all variants mentioned above.

Product properties

Material

Make sure the device materials are compatible with the fluid you are using.

Detailed information can be found in chapter [“4.1. Bürkert resistApp” on page 7.](#)

Detailed information on the materials can be found in chapter [“4.2. Material specifications” on page 8.](#)

Non wetted parts

Screw	Stainless steel
Female cable plug	Body, contact holder and cable gland in PA

Wetted parts

Axis	Ceramics (Al ₂ O ₃)
Seal	FKM or EPDM, depending on the sensor-fitting variant S030

Compatibility	Any pipe from DN 06...DN 65 which are fitted with Bürkert S030 Inline sensor-fitting. For the selection of the nominal diameter of the Inline sensor-fittings, see data sheet Type S030 ▶.
---------------	---

Pipe diameter	DN 06...DN 65
---------------	---------------

Dimensions	Detailed information can be found in chapter “5. Dimensions” on page 9.
------------	---

Measuring principle	Paddle wheel
---------------------	--------------

Performance data

Measurement deviation	<ul style="list-style-type: none"> • Teach-in: ± 1 % of the measured value^{1.)} at teach flow rate value • Standard K factor: ± 2.5 % of the measured value^{1.)}
-----------------------	--

Linearity	± 0.5 % of full scale ^{1.)}
-----------	--------------------------------------

Repeatability	± 0.4 % of the measured value ^{1.)}
---------------	--

Electrical data

Power source (not supplied)	Limited power source according to UL/EN 60950-1 standards or limited energy circuit according to UL/EN 61010-1 paragraph 9.4
-----------------------------	--

Protection against DC polarity reversal	Yes
---	-----

Voltage supply cable	<ul style="list-style-type: none"> • Cable with maximum operating temperature greater than 80 °C • Max. 50 m length, shielded • External diameter of wire: 5...8 mm • Cross section of wires: 0.25...1.5 mm²
----------------------	---

Medium data

Viscosity	Max. 300 cSt
Rate of solid particles	Max. 1 %
Maximum particle size	0.5 mm

Process/Pipe connection & communication

Electrical connection	Female cable plug according to DIN EN 175301-803
-----------------------	--

Approvals and certificates**Directives**

CE directive	The applied standards, which verify conformity with the EU Directives, can be found on the EU Type Examination Certificate and/or the EU Declaration of conformity (if applicable)
Pressure equipment directive	Complying with article 4, paragraph 1 of 2014/68/EU directive Detailed information on the pressure equipment directive can be found in chapter “3.1. Pressure equipment directive” on page 7.

Environment and installation

Relative air humidity	≤80 %, without condensation
Height above sea level	Max. 2000 m
Operating condition	Continuous
Equipment mobility	Fixed
Application range	Indoor and outdoor Protect the device against electromagnetic interference, ultraviolet rays and, when installed outdoors, against the effects of climatic conditions.
Degree of protection according to IEC/EN 60529	IP65 under the following simultaneous conditions: <ul style="list-style-type: none"> • device wired • cable plug mounted and tightened
Installation category	Category I according to UL/EN 61010-1
Pollution degree	Degree 2 according to UL/EN 61010-1

1.) Under reference conditions i.e. measuring fluid = water, ambient and water temperature = 20 °C (68 °F), while maintaining the minimum inlet and outlet distances and the appropriate internal diameters of the pipes.

1.3. Flowmeter with an Hall or Hall “Low Power” transducer**Note:**

If the device is mounted in a humid environment or outside, then the maximum voltage allowed is **35 V DC** instead of 36 V DC.

**Product properties****Material****Non wetted parts**

Cover (male fixed plug)	PC
Housing	PC
Bayonet system	PC
Female cable plug	Cable gland seal and flat seal in NBR

Wetted parts

Sensor armature	Stainless steel (316L - 1.4404), brass (CuZn ₃₉ Pb ₂), PVC, PP or PVDF (depending on S030 variant)
Bearing	Ceramics (Al ₂ O ₃)
Paddle wheel	PVDF
Sensor-fitting body	Stainless steel (316L - 1.4404), brass (CuZn ₃₉ Pb ₂), PVC, PP or PVDF (depending on S030 variant)
Measuring range	<ul style="list-style-type: none"> • Flow rate: 0.5...1000 l/min (0.13...265 gpm) • Flow velocity: 0.3...10 m/s

Electrical data

Operating voltage	<ul style="list-style-type: none"> Hall variant: 12...36 V DC \pm 10 %, filtered and regulated Connection to main supply: permanent, through external SELV (Safety Extra Low Voltage) and LPS (Limited Power Source) power supply Hall "Low Power" variant: via the connected Bürkert transmitter
Current consumption	<p>With sensor</p> <ul style="list-style-type: none"> Hall variant: \leq 30 mA Hall "Low Power" variant: \leq 0.8 mA
Output	<ul style="list-style-type: none"> Hall variant: <ul style="list-style-type: none"> 2 transistors, pulse output NPN and PNP, open collector, max. 100 mA frequency: 0...300 Hz NPN output: 0.2...36 V DC PNP output: supply voltage duty cycle (pulse duration/period): $\frac{1}{2} \pm 10 \%$ Hall "Low Power" variant: <ul style="list-style-type: none"> 1 transistor, pulse output NPN, open collector, max. 10 mA frequency: 0...300 Hz duty cycle (pulse duration/period): $\frac{1}{2} \pm 10 \%$

Medium data

Fluid temperature	<p>With sensor-fitting S030 in:</p> <ul style="list-style-type: none"> PVC: 0...+50 °C (+32...+122 °F) PP: 0...+80 °C (+32...+176 °F) PVDF, stainless steel or brass: -15...+100 °C (+5...+212 °F) <p>See data sheet Type S030 ▶ for more information.</p>
Fluid pressure	<p>With sensor-fitting S030 in:</p> <ul style="list-style-type: none"> plastic: max. PN 10 metal: max. PN 16 (PN 40 on request) <p>See data sheet Type S030 ▶ for more information.</p>

Process/Pipe connection & communication

Pipe connection	<p>With sensor-fitting S030 in:</p> <ul style="list-style-type: none"> plastic: true union, spigot or external thread metal: internal or external thread, weld ends, Clamp or flange <p>See data sheet Type S030 ▶ for more information.</p>
-----------------	---

Environment and installation

Ambient temperature	Operation and storage: -15...+60 °C (+5...+140 °F)
---------------------	--

1.4. Flowmeter with coil transducer for high temperature (variant 8030-HT)

Note:

If the device is mounted in a humid environment or outside, then the maximum voltage allowed is **35 V DC** instead of 36 V DC.



Product properties

Material

Non wetted parts

Cover (male fixed plug)	PPS, glass fibre reinforced
Housing	PPS, glass fibre reinforced
Bayonet system	PPS, glass fibre reinforced
Female cable plug	Cable gland seal in NBR and flat seal in silicone

Wetted parts

Sensor armature	Stainless steel
Bearing	Iglidur®
Paddle wheel	Stainless steel (316L - 1.4404)
Sensor-fitting body	Stainless steel
Measuring range	<ul style="list-style-type: none"> Flow rate: 0.85...1000 l/min (0.22...265 gpm) Flow velocity: 0.5...10 m/s

Electrical data

Power supply	12...36 V DC $\pm 10\%$, filtered and regulated Connection to main supply: permanent, through external SELV (Safety Extra Low Voltage) and LPS (Limited Power Source) power supply
Current consumption	≤ 10 mA (no load)
Output	<ul style="list-style-type: none"> 2 transistors, pulse output NPN and PNP, open collector Max. 700 mA Frequency: 0...250 Hz NPN output: 0.2...30 V DC PNP output: supply voltage Duty cycle (pulse duration/period): $\frac{1}{2} \pm 10\%$ Protected against overvoltage, polarity reversals and short circuit

Medium data

Fluid temperature	-15...+125 °C (+5...+257 °F)
Fluid pressure	<ul style="list-style-type: none"> Max. PN 40 for -15...+90 °C temperature range Max. PN 25 for +90...+125 °C temperature range

Process/Pipe connection & communication

Pipe connection	With sensor-fitting Type S030-HT: Internal or external thread, weld ends (clamps or flanges on request) Detailed information can be found in the data sheet of the Inline sensor-fittings variant high temperature (S030-HT), see data sheet Type S030 ▶.
-----------------	--

Environment and installation

Ambient temperature	Operation and storage: -15...+80 °C (+5...+176 °F)
---------------------	--

2. Product versions

The flowmeter is available with frequency output in three variants:

- Hall variant** with two transistor outputs NPN and PNP.
 The flowmeter requires an external power supply of 12...36 V DC. The output signal is designed for connection to any system with open collector NPN or PNP frequency input.
 This variant is intended, for example, for connection to Universal flow transmitters or batch controller Type 8025, to pulse divider Type 8022, to eCONTROL universal controller Type 8611 or to multiCELL transmitter/controller Type 8619.
 See [data sheet Type 8025](#) ▶, [data sheet Type 8022](#) ▶, [data sheet Type 8611](#) ▶, [data sheet Type 8619](#) ▶ for more information.
- Hall “Low Power” variant** with one NPN transistor “Low Power” output.
 The flowmeter requires an external power supply of 12...36 V DC, provided by the connected Bürkert transmitter.
 This variant is **only** intended for connection to the Bürkert device Type 8025 in its flow transmitter for “Low Power” flowmeters Type 8025 or to 4...20 mA flow transmitter Type 8022.
 See [data sheet Type 8025](#) ▶, [data sheet Type 8022](#) ▶ for more information.
- High temperature variant (SE30-HT)** with two transistor outputs NPN and PNP.
 The flowmeter requires an external power supply of 12...36 V DC. The output signal is designed for connection to any system with open collector NPN or PNP frequency input. This variant is intended, for example, for connection to Universal flow transmitters or batch controller Type 8025, to pulse divider Type 8022, to eCONTROL universal controller Type 8611 or to multiCELL transmitter/controller Type 8619.
 See [data sheet Type 8025](#) ▶, [data sheet Type 8022](#) ▶, [data sheet Type 8611](#) ▶, [data sheet Type 8619](#) ▶ for more information.

In a 3-wire system, the signal can be connected to a display or processed directly. The electrical connection is provided via a cable plug according to DIN EN 175301-803.

3. Approvals

3.1. Pressure equipment directive

The device conforms to article 4, paragraph 1 of the pressure equipment directive 2014/68/EU under the following conditions:

Device used on a pipe

Note:

- The data in the table is independent of the chemical compatibility of the material and the fluid.
- PS = maximum admissible pressure (in bar), DN = nominal diameter of the pipe

Type of fluid	Conditions
Fluid group 1, article 4, paragraph 1.c.i	DN ≤ 25
Fluid group 2, article 4, paragraph 1.c.i	DN ≤ 32 or PS*DN ≤ 1000
Fluid group 1, article 4, paragraph 1.c.ii	DN ≤ 25 or PS*DN ≤ 2000
Fluid group 2, article 4, paragraph 1.c.ii	DN ≤ 200 or PS ≤ 10 or PS*DN ≤ 5000

4. Materials

4.1. Bürkert resistApp

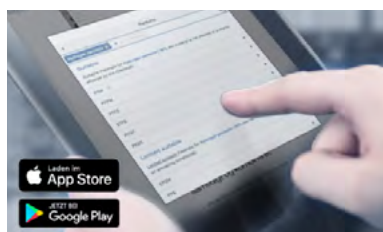

Bürkert resistApp – Chemical resistance chart

You want to ensure the reliability and durability of the materials in your individual application case? Verify your combination of media and materials on our website or in our resistApp.

[Start Chemical Resistance Check](#)

4.2. Material specifications

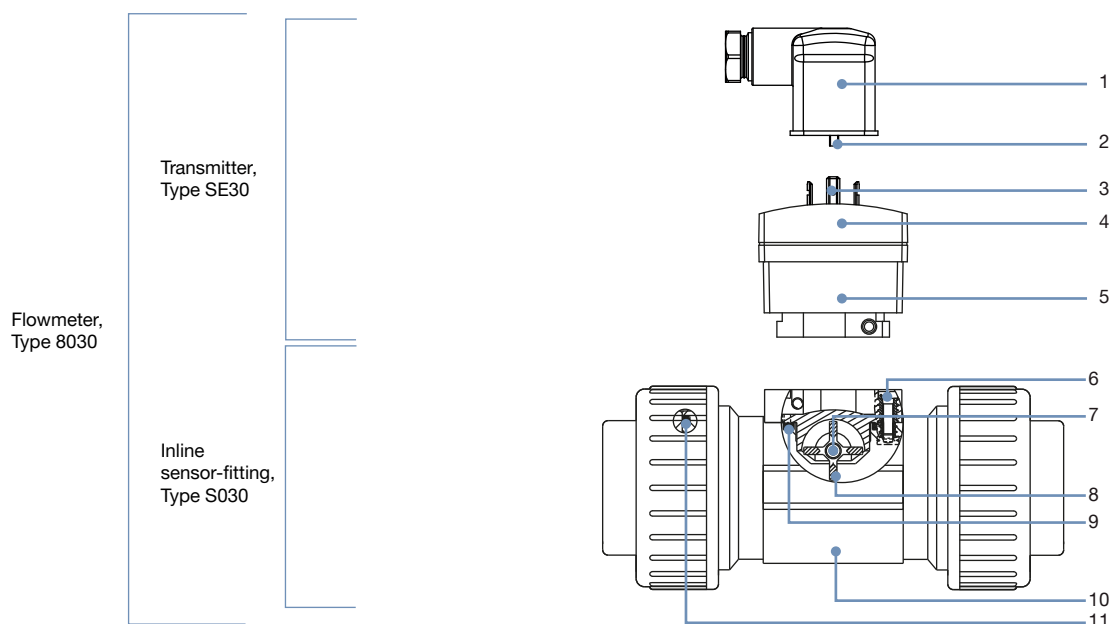

No.	Element	Material
1	Female cable plug (DIN EN 175301-803)	<ul style="list-style-type: none"> Body, contact holder and cable gland in PA Cable gland seal in NBR and flat seal in NBR or in silicone for variant 8030-HT
2	Screws	Stainless steel
3	Electrical contact	Sn
4	Cover (male fixed plug)	PC
5	Housing	<ul style="list-style-type: none"> PC or PPS, glass fibre reinforced (for variant 8030-HT)
6	Screws	Stainless steel
7	Axis and bearing	<ul style="list-style-type: none"> Axis in ceramics (Al_2O_3) Bearings in: <ul style="list-style-type: none"> ceramics (Al_2O_3) Iglidur® (for variant 8030-HT)
8	Paddle wheel	<ul style="list-style-type: none"> PVDF Stainless steel (for variant 8030-HT)
9	Seal	FKM or EPDM (depending on the sensor-fitting variant S030)
10	Sensor-fitting body	<ul style="list-style-type: none"> Stainless steel (316L - 1.4404), brass ($CuZn_{39}Pb_2$), PVC, PP, PVDF (depending on S030 variant) Stainless steel (316L - 1.4404) (8030-HT)
11	Seals	FKM or EPDM (depending on S030 variant and only for true union connection with nut and solvent/fusion socket)

5. Dimensions

5.1. Transmitter Type SE30

Note:

Dimensions in mm, unless otherwise stated

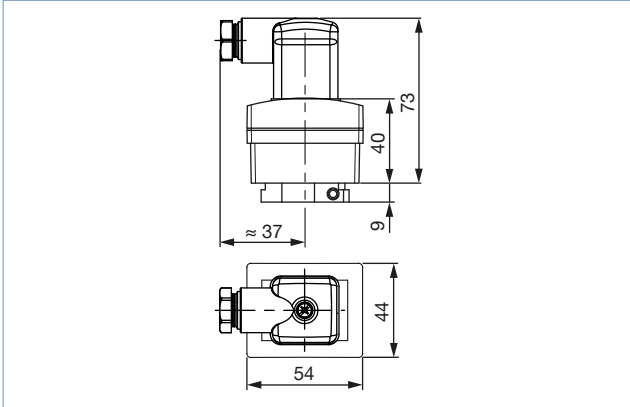

5.2. Transmitter SE30 mounted in a sensor-fitting Type S030

Note:

Dimensions in mm, unless otherwise stated

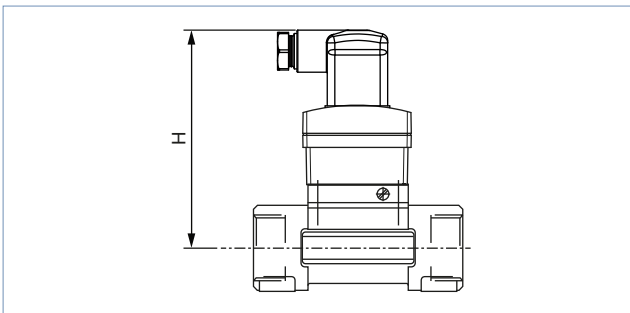

DN	H
06	102.5
08	102.5
15	107.5
20	105.0
25	105.0
32	109.0
40	112.5
50	119.0
65	119.0

6. Performance specifications

6.1. Pressure temperature diagram

Flowmeter with an Hall or Hall "Low Power" transducer

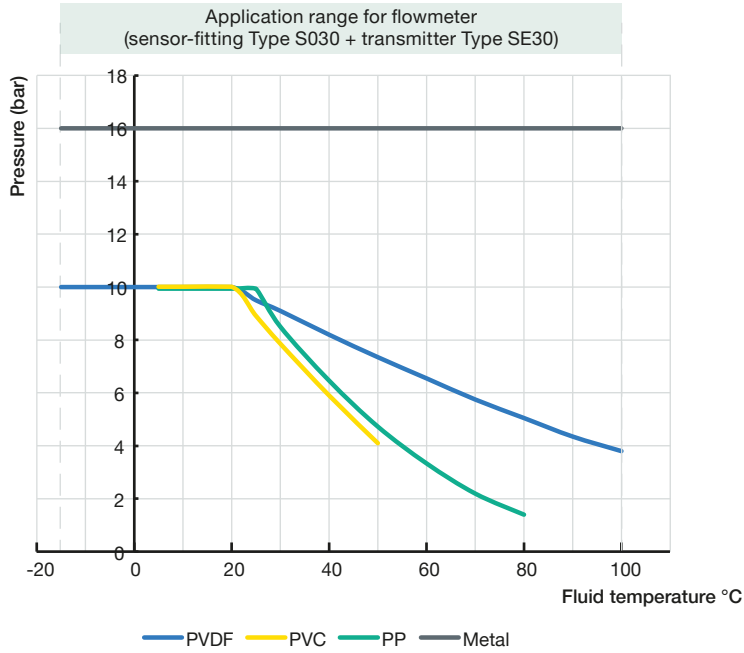

Flowmeter with coil transducer for high temperature (variant 8030-HT)

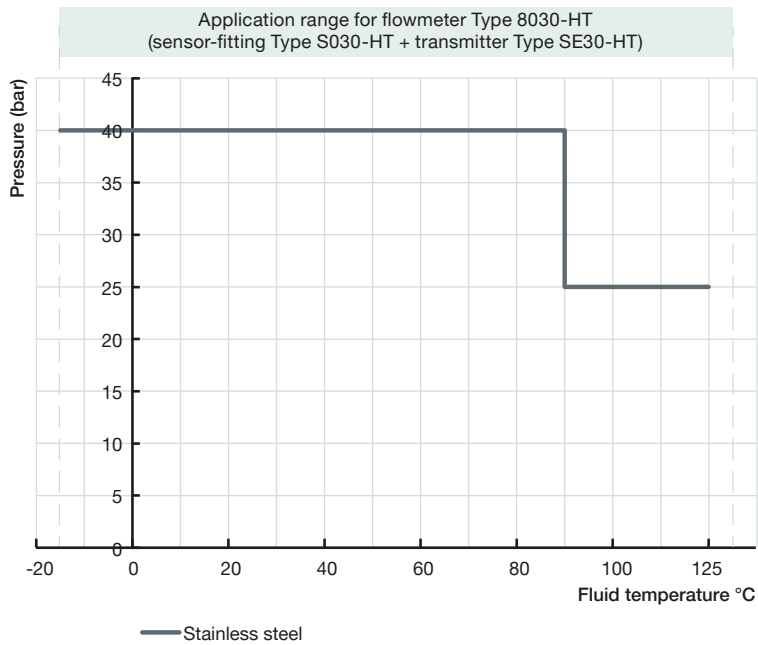

7. Product installation

7.1. Installation notes

Note:

The device is not suitable for use in gaseous media and steam.

Minimum straight distances upstream and downstream of the sensor must be observed. These stabilizing distances depend on the pipe's design. Increasing these distances or installing a flow conditioner may be necessary to obtain the best accuracy. For more information, refer to EN ISO 5167-1.

EN ISO 5167-1 specifies the straight inlet and outlet distances that must be complied with when installing fittings in pipe lines in order to achieve calm flow conditions. The most commonly used elements that could lead to turbulence in the flow are shown below. The related minimum inlet and outlet distances that ensure a calm flow are also specified.

Make sure that the measuring conditions at the point of measurement are calm and problem-free.

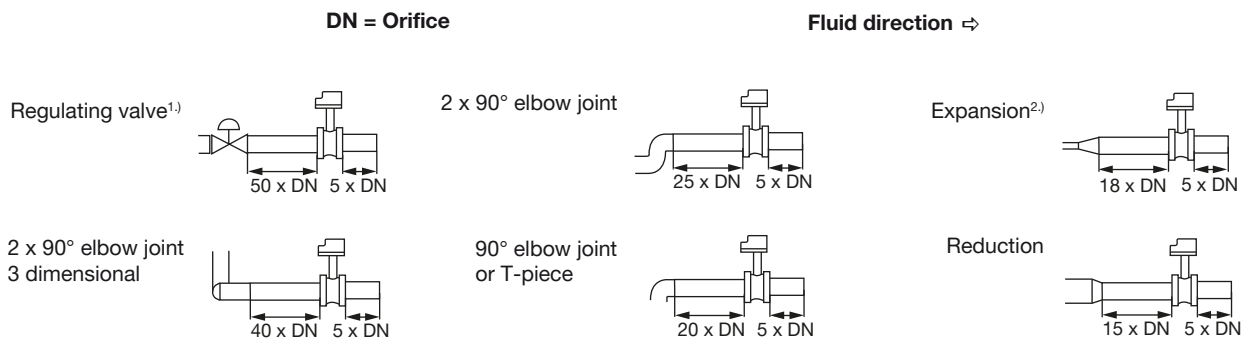

1.) If the valve cannot be mounted after the measuring device, the minimal distances have to be respected.

2.) If an expansion cannot be avoided, the minimal distances have to be respected.
Please note minimum flow velocity

The device can be installed in either horizontal or vertical pipes, but following additional conditions should be respected:

- The pipe always has to be filled with fluid at all times near the device.
- The pipe design must be such that no air bubbles or cavitation can form within the medium near the device at any time.

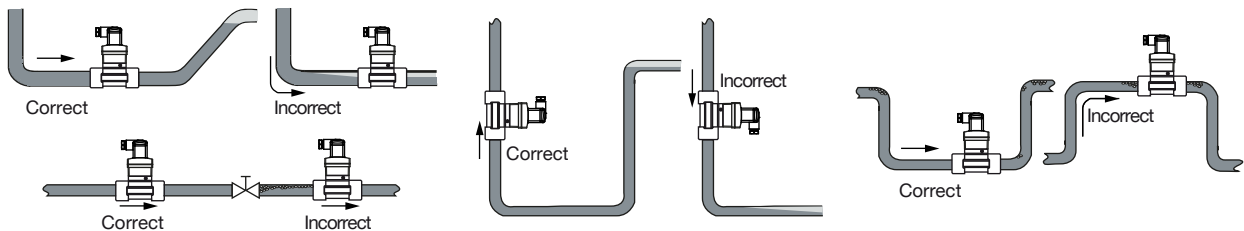

Pressure and temperature ratings must be respected according to the selected fitting material. The suitable pipe size is selected using the diagram in the chapter "Nominal size selection" of the **data sheet Type S030** ▶.

8. Product operation

8.1. Measuring principle

When liquid flows through the pipe, the paddle wheel with 4 inserted magnets is set in rotation, producing a measuring signal in the sensor (Hall sensor). The frequency modulated induced voltage is proportional to the flow velocity of the fluid.

A K factor, specific to each pipe, enables the conversion of this frequency into a flow rate.

This K factor is available in the fittings' instruction manual, see **Type S030** ▶.

9. Product design and assembly

9.1. Product assembly

Note:

- The device Type 8030 is made up of a Bürkert Inline sensor-fitting Type S030 equipped with a paddle wheel sensor and a transmitter Type SE30.
- The Inline sensor-fitting Type S030 ensures simple installation into pipes from DN 06...DN 65. The transmitter Type SE30 can easily be installed into any sensor-fitting system Type S030, by means of a bayonet fastening.

See **data sheet Type S030** ▶ for more information.

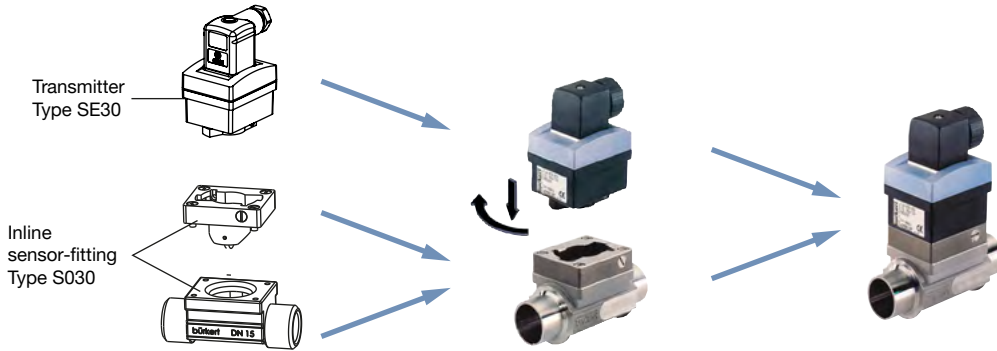

10. Networking and combination with other Bürkert products

Example:

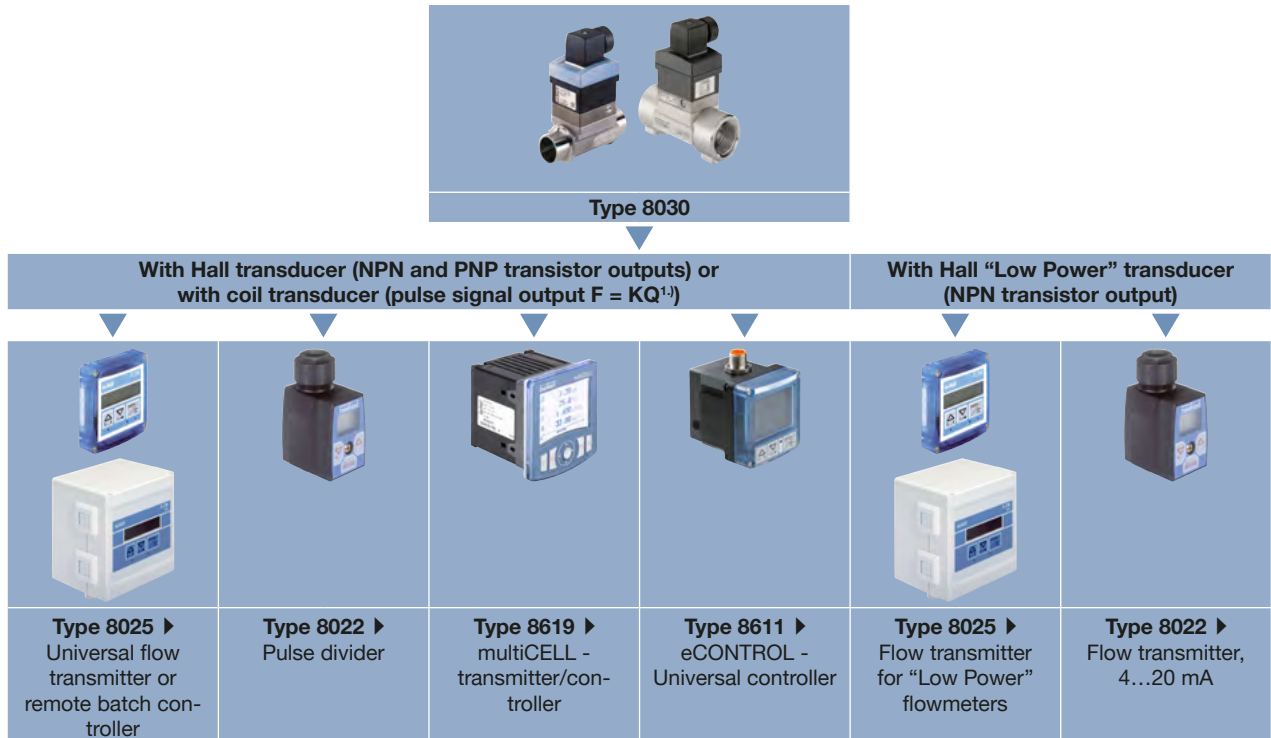

1.) Output: F = frequency [Hertz], K = K factor of the Inline sensor-fitting [pulse/liter] and Q = flow rate [l/s]

11. Ordering information

11.1. Bürkert eShop



Bürkert eShop – Easy ordering and quick delivery

You want to find your desired Bürkert product or spare part quickly and order directly? Our online shop is available for you 24/7. Sign up and enjoy all the benefits.

[Order online now](#)

11.2. Recommendation regarding product selection

A complete flowmeter Type 8030 consists of a flow transmitter Type SE30 and a Bürkert Inline sensor-fitting Type S030.

See [data sheet Type S030](#) ▶ for more information.

Two different components must be ordered in order to select a complete device. The following information is required:

- **Article no.** of the desired compact Type SE30 flow transmitter (see chapter [“11.4. Ordering chart”](#) on page 14)
- **Article no.** of the selected Type S030 Inline sensor-fitting (see [data sheet Type S030](#) ▶)

11.3. Bürkert product filter





Bürkert product filter – Get quickly to the right product

You want to select products comfortably based on your technical requirements? Use the Bürkert product filter and find suitable articles for your application quickly and easily.

[Try out our product filter](#)

11.4. Ordering chart

Transmitter Type SE30

Description	Operating voltage	Output	Electrical connection	Article no.
Hall variant (connectable to Type 8025 universal transmitter, or batch controller, Type 8619, Type 8611, Type 8022 pulse divider or to a PLC)	12...36 V DC	Frequency with pulse, transistors PNP and NPN, open collector	Female cable plug DIN EN 175301-803	423913 
Hall "Low Power" variant (only connectable to the flow transmitter for "Low Power" flowmeters Type 8025 or to the flow transmitter Typ 8022)	From associated transmitter	Frequency with pulse, transistor NPN, open collector		423914 
High Temperature (SE30-HT) variant ^{1.)} (connectable to Type 8025 universal transmitter or batch controller, Type 8619, Type 8611, Type 8022 pulse divider or to a PLC)	12...36 V DC	Frequency with pulse, transistors PNP and NPN, open collector		449694 

1.) Only mount with Inline sensor-fitting in High Temperature variant (**S030-HT**)







Further versions on request



Approval

ATEX for hazardous areas II 1 G/D - II 3 GD, NAMUR or NPN/PNP variant
See **data sheet Type SE30 Ex**  for more information.

11.5. Ordering chart accessories

Description	Article no.
Electrical connection	
Female cable plug DIN EN 175301-803 with cable gland - see Type 2518 	572264 
Female cable plug DIN EN 175301-803 with cable gland, flat seal in silicone (only for 8030-HT variant) - see Type 2518 	572330 
Female cable plug DIN EN 175301-803 with NPT ½" reduction without cable gland - see Type 2509 	162673 

Bürkert – Close to You

For up-to-date addresses
please visit us at
www.burkert.com

DTS 1000011081 EN Version: AD Status: RL (released | freigegeben | validé) printed: 11.07.2023

Austria
Belgium
Czech Republic
Denmark
Finland
France
Germany
Italy
Netherlands

Norway
Poland
Spain
Sweden
Switzerland
Turkey
United Kingdom

